



**INSTRUCTION MANUAL  
USE AND MAINTENANCE  
LIFTING TROLLEY FOX**  
Serial number ----



|                  |   |  |  |  |  |  |  |
|------------------|---|--|--|--|--|--|--|
| <b>Dalmi srl</b> | Instruction manual: lifting trolley FOX |  |  |  |  |  |  |
| Date             | 18-12-2015                              |  |  |  |  |  |  |
| Revision         | Ver.0                                   |  |  |  |  |  |  |

**DECLARATION OF CONFORMITY**  
in accordance with directive  
2006/42/EC annex II, point A



**DALMI s.r.l.**  
Via dei Roccoli, 1  
36071 Arzignano (Vicenza) - Italy

**Declares under its own responsibility that the lifting trolley**

|                           |                            |
|---------------------------|----------------------------|
| <b>Type</b>               | <b>Lifting trolley FOX</b> |
| <b>Serial number</b>      | <b>----</b>                |
| <b>Date of production</b> | <b>18-12-2015</b>          |

It is in accordance with the law:  
• Machinery directive 2006/42/EC

The person authorised to compile the technical file of the machine is the legal representative of DALMI s.r.l. domicile at the registered office of the company.

They maintain their compliance if correctly assembled according to our instructions for putting into service, installation and maintenance.

Arzignano (VI), December 18, 2015

Legal representative  
Mr. Dal Maso Mariano

|                  |   |  |  |  |  |  |  |
|------------------|---|--|--|--|--|--|--|
| <b>Dalmi srl</b> | Instruction manual: lifting trolley FOX |  |  |  |  |  |  |
| Date             | 18-12-2015                              |  |  |  |  |  |  |
| Revision         | Ver.0                                   |  |  |  |  |  |  |



DALMI srl  
 Via Dei Roccoli, 1  
 36071 ARZIGNANO(VI)  
 Tel +39 329 6726059  
 Fax+39 0444 670229



|   |                                 |  |                           |
|---|---------------------------------|--|---------------------------|
| <b>MACCHINA TIPO:</b><br><b>MACHINE TYPE</b>      | <b>Carrello sollevatore FOX</b> |  |                           |
| <b>Nr. MATRICOLA:</b><br><b>SERIAL NUMBER</b>     | ----                            | <b>MODELLO:</b><br><b>MODEL</b>              | FOX                       |
| <b>ANNO:</b><br><b>YEAR</b>                       | 2016                            | <b>BATTERIA VOLT:</b><br><b>BATTERY VOLT</b> | 24 V<br>(2x 12V-7A)       |
| <b>PESO KART max.:</b><br><b>WEIGHT KART max.</b> | 120 kg                          | <b>PESO:</b><br><b>WEIGHT</b>                | 26 kg<br>(+ Batterie 5kg) |

|                  |  |  |  |  |  |  |  |
|------------------|--|--|--|--|--|--|--|
| <b>Dalmi srl</b> | <b>Instruction manual: lifting trolley FOX</b> |  |  |  |  |  |  |
| Date             | 18-12-2015                                     |  |  |  |  |  |  |
| Revision         | Ver.0  |  |  |  |  |  |  |

## Index

| <b>Cap.</b> |  | <b>Pag.</b> |
|-------------|--|-------------|
|             | Declaration of conformity                        | 2           |
|             | Symbology  | 5           |
| 1           | General information                              | 6           |
| 1.1         | Purpose and contents of the manual               | 6           |
| 1.2         | General warnings                                 | 7           |
| 1.3         | Requirements and regulations                     | 7           |
| 1.4         | Risk list  | 8           |
| 2           | Description and technical specifications         | 9           |
| 3           | Testing  | 11          |
| 4           | Cargo & storage                                  | 11          |
| 5           | Installation                                     | 11          |
| 6           | Operating rules (starts and stops)               | 12          |
| 7           | Maintenance and periodic cleaning of the machine | 17          |
| 8           | Malfunctions                                     | 18          |
| 9           | Commissioning                                    | 19          |

|                  |  |  |  |  |  |  |  |
|------------------|--|--|--|--|--|--|--|
| <b>Dalmi srl</b> | <b>Instruction manual: lifting trolley FOX</b> |  |  |  |  |  |  |
| Date             | 18-12-2015                                     |  |  |  |  |  |  |
| Revision         | Ver.0  |  |  |  |  |  |  |

**SYMBOLGY FOR THE SAFETY OF PERSONS AND PROPERTY**



Danger of electric shock



Danger of crushing



Obligation to consult the manual



Do not remove the safety guards and devices

|                  |  |  |  |  |  |  |  |
|------------------|--|--|--|--|--|--|--|
| <b>Dalmi srl</b> | <b>Instruction manual: lifting trolley FOX</b> |  |  |  |  |  |  |
| Date             | 18-12-2015                                     |  |  |  |  |  |  |
| Revision         | Ver.0  |  |  |  |  |  |  |

## Chapter 1 GENERAL INFORMATION

### 1.1 Purpose and contents of the manual

This manual refers to the lifting trolley used to lift and handle the kart, it contains the machine description, specifications, instructions to allow the installation, use and maintenance, safe.

The instruction manual does not replace the obligations imposed by legislation on safety and accident prevention. Therefore the company DALMI s.r.l. declines all responsibility (and will void the warranty and safety certification, making the user responsible) caused by:

- ✓ lack of or incorrect observance of instructions included in this manual;
- ✓ battery with characteristics that do not conform to the instructions in the manual;
- ✓ modifications or repairs performed differently from what is stated in the manual;
- ✓ use by untrained personnel.

The manual is intended for:

- a) to people running the installation;
- b) to people who use the lift;
- c) people who perform maintenance.

**The manual must be kept so that it is always available for consultation, in great condition. It is available on the website of Dalmi.**

Who uses the folding car lift must be thoroughly familiar with the contents of this manual, in addition these recommendations do not represent the only procedures for safety; each operation performed on moving parts, such as installation and maintenance requires special care, guaranteed only by qualified and properly trained.

**Failure to follow these warnings and/or tampering with the safety devices of the machine, will raise the DALMI s.r.l. from any liability in the event of an accident to personnel or damage to property and/or the machine.**

### 1.2 General warnings

- 1) knowledge of the information and requirements contained in this publication is essential for proper use of the lifting trolley.
- 2) The user's interventions on the machine are permitted only to the extent of its competence and as it has been previously trained.
- 3) The user must be aware of the workings of the lifting trolley according to its competence; However it is to learn the controls and stop the lift. It is borne by the individual brings into service, make sure that the users are trained and are aware of all the information and instructions in the documentation provided.
- 4) Are the responsibility of the user to any work necessary for maintaining efficiency of lifting trolley, during and prior to its use. The control that the gradual deterioration, wear and tear, wear, dust, oxidation, pollution, decay, fouling, corrosion during operation of the machine does not produce damage is the sole responsibility of the user. Damage resulting from the use of the machine in such a way that does not comply with the requirements set out in the preceding paragraphs are considered damages that the user could have avoided using ordinary diligence.
- 5) In addition, the operator which operates on the machine is obliged to comply with the safety standards in force, and in particular:
  - The lifting trolley must be stopped with the battery disconnected whenever action is required beyond that requires removing the fairings and protections.

|                  |  |  |  |  |  |  |  |
|------------------|--|--|--|--|--|--|--|
| <b>Dalmi srl</b> | <b>Instruction manual: lifting trolley FOX</b> |  |  |  |  |  |  |
| Date             | 18-12-2015                                     |  |  |  |  |  |  |
| Revision         | Ver.0  |  |  |  |  |  |  |

### 1.3 Requirements and regulations

**2006/42/CE** Machinery directive;

Ripair:









- EN ISO 12100: Safety of machinery. Fundamental concepts of evaluation and risk reduction;
- ISO 14120: Fixed guards and requirements of systems and fasteners;
- UNI EN ISO 13857: Safety distances to prevent danger zones being reached by the upper limbs and lower limbs;
- UNI EN 349: Minimum gaps to avoid crushing of parts of the body;
- UNI ISO 11228-1: Ergonomics-manual handling-part 1: lifting and transport;
- UNI ISO 11228-2: Ergonomics-manual handling-part 2: Boost and towing.

|                  |  |  |  |  |  |  |  |
|------------------|--|--|--|--|--|--|--|
| <b>Dalmi srl</b> | <b>Instruction manual: lifting trolley FOX</b> |  |  |  |  |  |  |
| Date             | 18-12-2015                                     |  |  |  |  |  |  |
| Revision         | Ver.0  |  |  |  |  |  |  |

**1.4 Risk list**

The lifting trolley is equipped with safety devices required to eliminate as far as possible any risk. The following table lists the risks and remedies adopted.

**RISK LIST**

| <b>Risk</b>  | <b>Solution</b>  | <b>Picture</b>  |
|--|--|---|
| Kart cart or bump against persons or objects.<br>Improper loading trolley for excess weight or incorrect positioning of the kart.              | In the manual and on the label is specified the weight lifting and weight of lifting trolley.<br>The manual describes our attentions to follow to do the lifting and handling operations by ensuring the safety of staff and objects.                                      |   |
| Crush, hands or fingers the base frame and front support.<br>Or between support hooks and front support.                                       | In the manual it is prescribed, that who rules the movement of lifting trolley, it must verify the absence of people in the working area of the machine.<br>In the manual it requires to remove the connection to the battery when you perform maintenance on the trolley. | <br>    |
| Crush, hands between motor support and support hooks.  | In the manual it is prescribed, that who rules the movement of lifting trolley, it must verify the absence of people in the working area of the machine.<br>In the manual it requires disconnecting the batteries when you do maintenance on cart.                         | <br> |
| Entanglement and crushing the organs of transmission of motion from the engine to the gear motor and belt pin                                  | In the manual is required to remove the protection and ban is imposed to disconnect the batteries when you do maintenance on cart.   | <br> |
| Unintentional start-up during installation or maintenance.<br>Accidental short circuits of the battery terminals, caused by an object handler. | Before performing operations (Assembly, disassembly, maintenance) on the lift, disconnect the batteries.   | <br> |



|                  |  |  |  |  |  |  |  |
|------------------|--|--|--|--|--|--|--|
| <b>Dalmi srl</b> | <b>Instruction manual: lifting trolley FOX</b> |  |  |  |  |  |  |
| Date             | 18-12-2015                                     |  |  |  |  |  |  |
| Revision         | Ver.0  |  |  |  |  |  |  |

## CHAPTER 2 DESCRIPTION AND TECHNICAL SPECIFICATIONS

The machine built by THEN srl, is a forklift handling electric karts.

FOX linkage structure is made of steel (or aluminium), on the frame are mounted two fixed wheels anti-drilling from 260 mm and two swivel wheels 160 mm.

The trolley frame is foldable with hooks and wheels removed, to save space during transportation.

The lift system is equipped with an electric motor, rotation of the pins that you wrap the straps, that move the top of the lift, composed by the support hooks and the front support.

On the lift motor mount is fitted with a limit switch, which is operated by the support hooks to avoid incorrect manoeuvres and to protect the drive system.

The electric motor is powered by a battery pack consisting of two lead-acid batteries (12 V/7 A), equipped with battery charger 24 V

### OPERATION:

- 1) Opening of the lift;
- 2) Apply hooks to the support hooks;
- 3) Insert the hooks of the lift on the chassis of the kart;
- 4) Act on the switch to raise the kart until it reaches the end position;
- 5) Handling;
- 6) Operate the switch to lower the kart;
- 7) Fold the chassis and disconnect the cables of the battery pack.

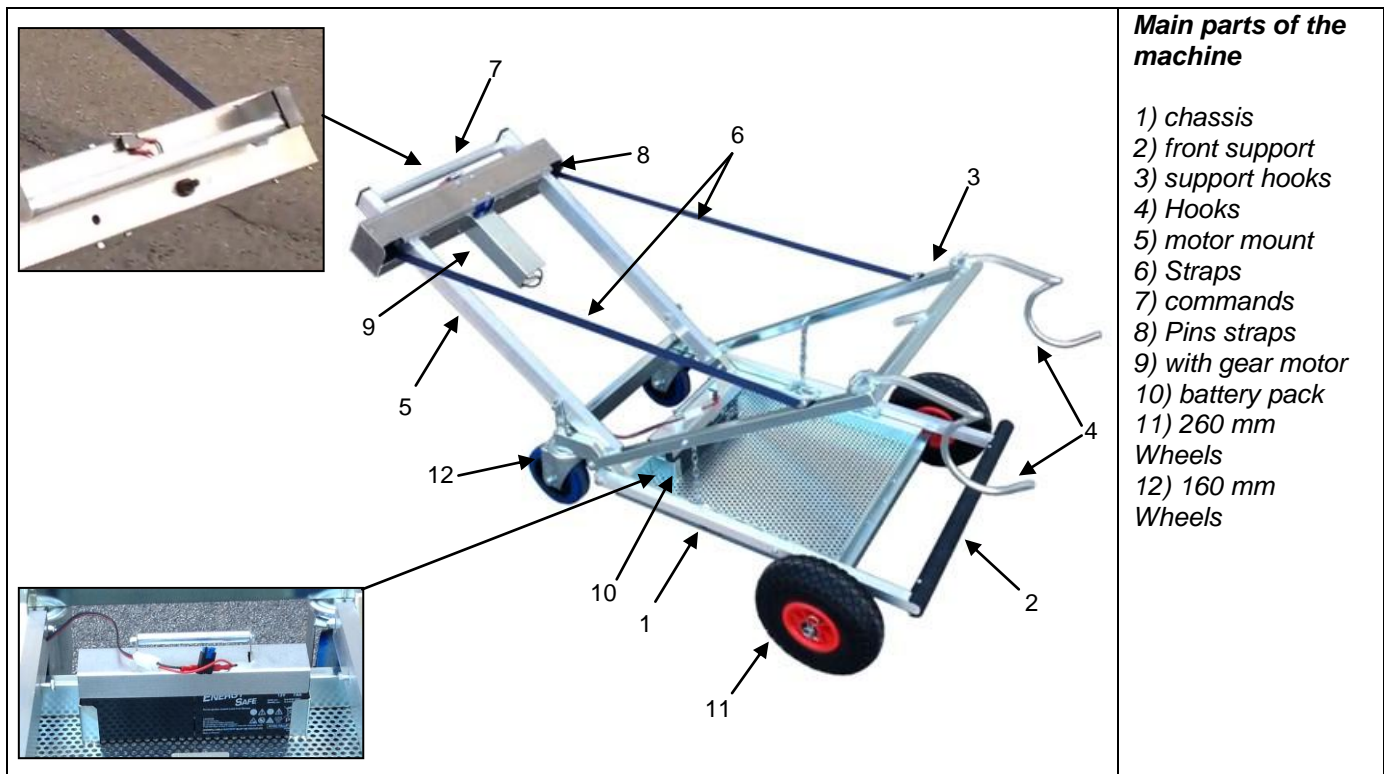

Picture 1

|                  |  |  |  |  |  |  |  |
|------------------|--|--|--|--|--|--|--|
| <b>Dalmi srl</b> | <b>Instruction manual: lifting trolley FOX</b> |  |  |  |  |  |  |
| Date             | 18-12-2015                                     |  |  |  |  |  |  |
| Revision         | Ver.0  |  |  |  |  |  |  |

**DATA SHEET**

|                        |  |
|------------------------|--|
| <b>TYPE:</b>           | Lifting trolley FOX                              |
| <b>SERIAL NUMBER:</b>  | Varies   |
| <b>DIMENSIONS:</b>     | 950mm x 750mm x (H)320mm                         |
| <b>WEIGHT:</b>         | 26 kg steel - 21 kg aluminum<br>Battery pack 5kg |
| <b>TENSION:</b>        | 24 V (n.2 batteries da 12 V / 7 A)               |
| <b>LIFTING WEIGHT:</b> | 120 kg   |

NOTES:

---



---



---

**ROUGH DIMENSIONAL DRAWING**

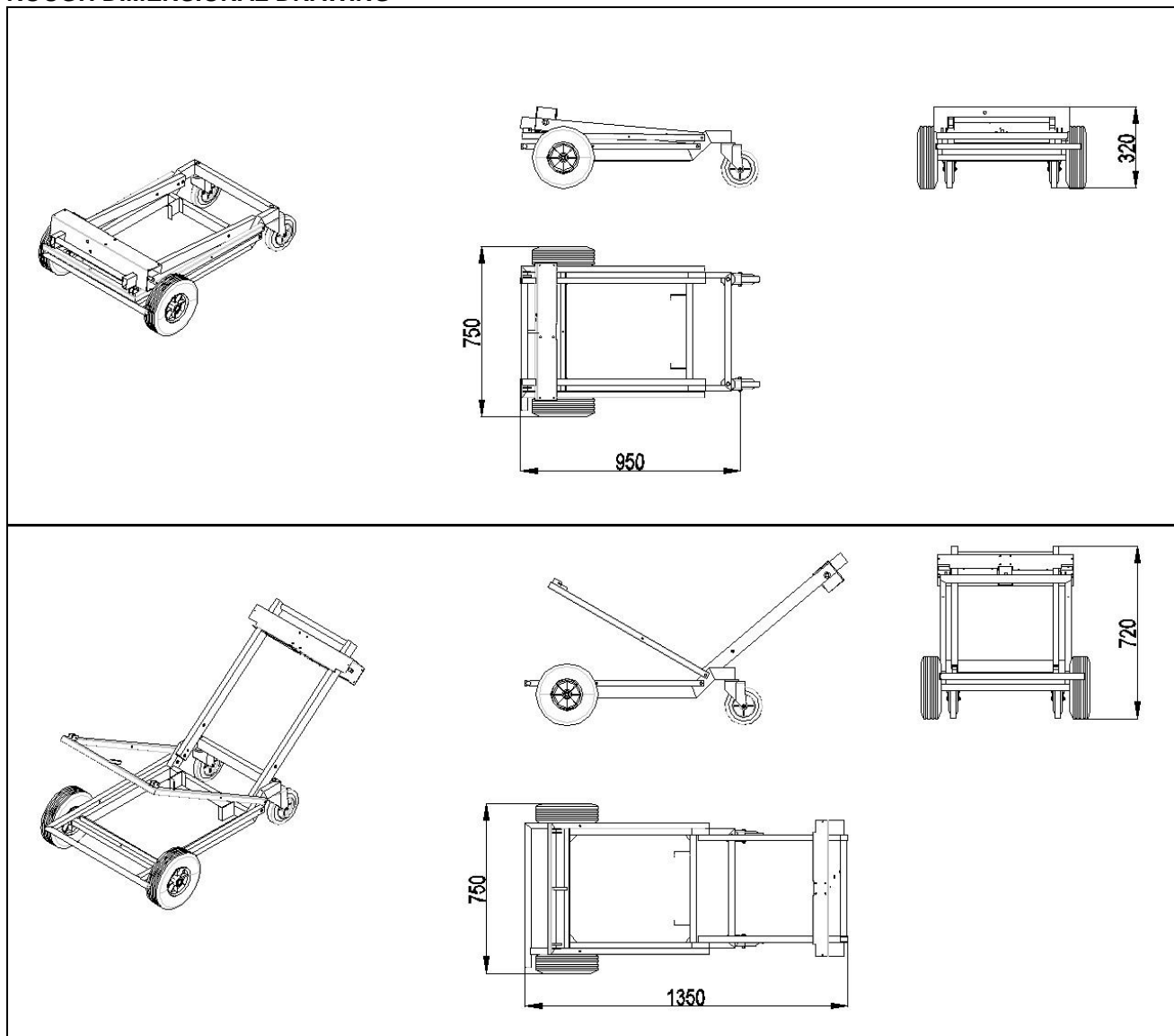

|                  |  |  |  |  |  |  |  |
|------------------|--|--|--|--|--|--|--|
| <b>Dalmi srl</b> | <b>Instruction manual: lifting trolley FOX</b> |  |  |  |  |  |  |
| Date             | 18-12-2015                                     |  |  |  |  |  |  |
| Revision         | Ver.0  |  |  |  |  |  |  |

**Chapter 3 – warranty and ACCEPTANCE TESTING**

The lifting trolley FOX, is checked and tested before having shipment approvals. Dimensional, functional and compliance controls to documents and reference standards.

The warranty starts from the date of delivery and covers all the parts for which it is agreed the actual imputability to the quality of workmanship or defective material. The warranty does not cover wear parts, electric motors, all damage caused by handling and transport, from the use, maintenance, machine repair performed by unauthorized persons and from the non-observance of the instruction manual.

**Chapter 4 CARGO & STORAGE**

**Transport**

When transporting be careful during all phases of the lifting, carrying, and positioning. Before lifting cart maneuvering test its weight; the value is reported on the rating plate and on the specifications of this manual. During lifting be careful that the carriage will not tipping over and make sure you have sufficient space to be able to move easily without danger of shock.

**!! Caution** do not lift the machine by the organs of movement, use points arranged in a frame.

**Storage**



If you anticipate a long period of storage, protect the system from bad weather conditions (weather and dust), in particular cover electrical components, bearings, on a monthly basis, check that no part affected by corrosion. Check the lubrication and that there is no condensation.

|                  |  |  |  |  |  |  |  |
|------------------|--|--|--|--|--|--|--|
| <b>Dalmi srl</b> | <b>Instruction manual: lifting trolley FOX</b> |  |  |  |  |  |  |
| Date             | 18-12-2015                                     |  |  |  |  |  |  |
| Revision         | Ver.0  |  |  |  |  |  |  |

## Chapter 5 MOUNTING

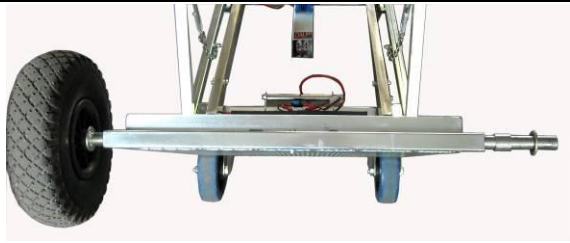
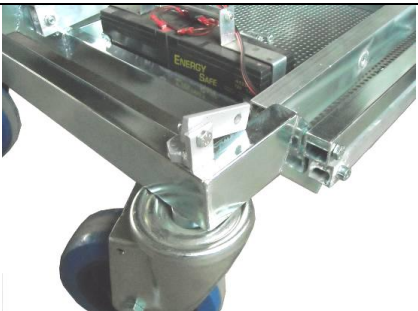
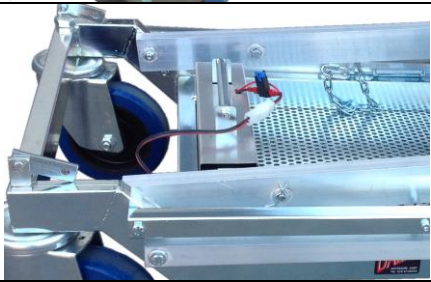
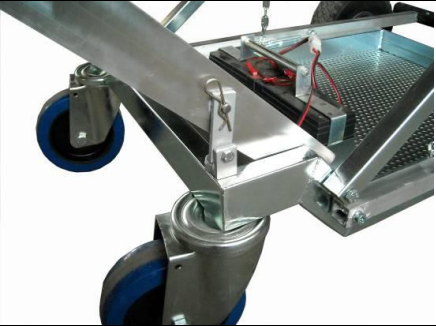

ALL INSTALLATION WORK MUST BE PERFORMED BY EDUCATED PEOPLE GENERIC HAZARDS ASSOCIATED WITH SUCH ACTIONS.

ATTENTION: who shall carry out the following operations must be provided with appropriate personal protective equipment (gloves, etc.).

|   |   |
|---|---|
|    | <p>Insert the wheel axle to the left push it until you find the hole in the middle of the tube<br/> Insert the screw M5x30 into the hole in the middle of the tube and fasten the nut (spanner 8)<br/> On the left side put the spacer, washer, wheel and finally the split pin.<br/> On the right side only insert the wheel and the split pin.</p>  |
|   | <p>The bolts of the rear wheels are left and right, must be welded plate facing out, fasten with spanner 24</p>   |
|  | <p>Insert the battery in its housing and connect the cables</p>   |
|  | <p><b>Opening:</b> lift the top of the shopping cart, when you get into position, slide the PIN from the inside to the outside and put the cotter pin (operation to be performed by both parties).</p>  |
|   | <p>Bring the support hooks to stop, to verify that the kart reaches a horizontal position, adjust the distance of the front support (the one attached with chains) using the bolts (this operation must be carried out, with empty cart).<br/> <b>Tie rod adjustment:</b> when you set the right position and the kart is horizontal, it is recommended to put a plastic strap between the ring and the center of the tensioner (to prevent the tie come loose with vibration).</p> |

|                  |  |  |  |  |  |  |  |
|------------------|--|--|--|--|--|--|--|
| <b>Dalmi srl</b> | <b>Instruction manual: lifting trolley FOX</b> |  |  |  |  |  |  |
| Date             | 18-12-2015                                     |  |  |  |  |  |  |
| Revision         | Ver.0  |  |  |  |  |  |  |

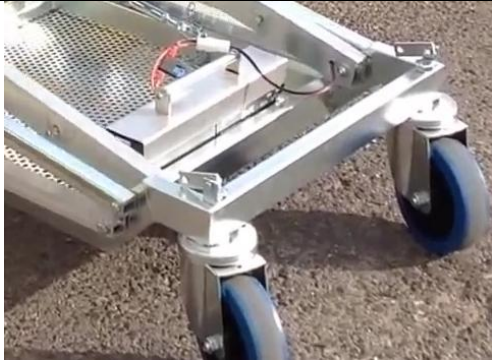
**Chapter 6 OPERATING RULES (starts and stops)**

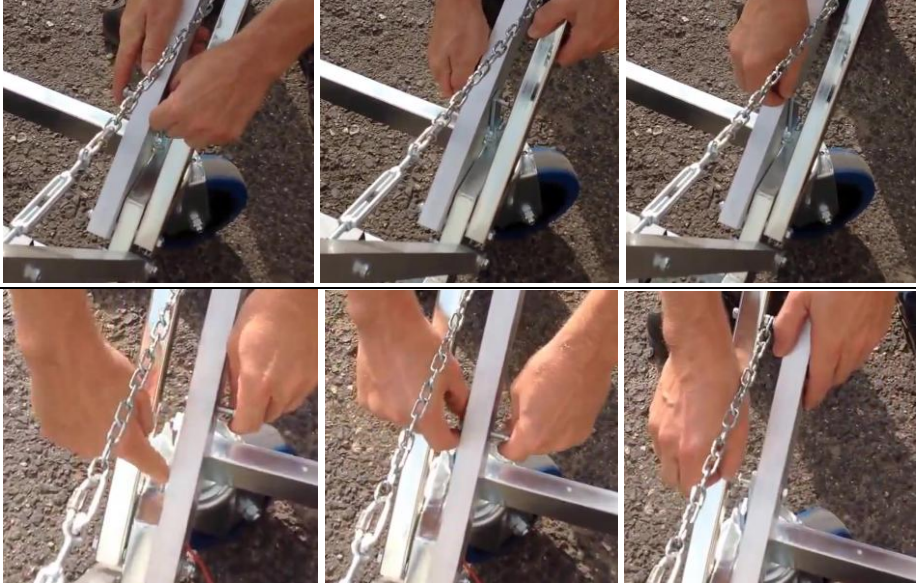
|  |  |
|--|--|
| <p><b>OPENING:</b> Insert the battery pack into place and connect the battery cables;</p>  |    |
| <p>Lift the top of the kartlift;</p>   |   |
| <p>Get in position</p>   |  |
| <p>Insert the pins from inside to outside and secure with the pins</p>  |  |

|                  |  |  |  |  |  |  |  |
|------------------|--|--|--|--|--|--|--|
| <b>Dalmi srl</b> | <b>Instruction manual: lifting trolley FOX</b> |  |  |  |  |  |  |
| Date             | 18-12-2015                                     |  |  |  |  |  |  |
| Revision         | Ver.0  |  |  |  |  |  |  |

**OPERATION:**

1) Move the switch to the left to loosen the straps:

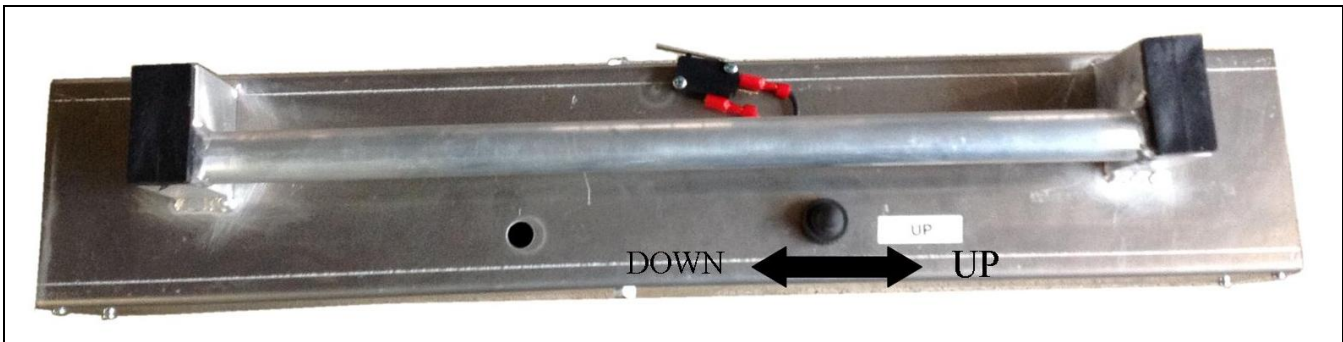

Picture 2

2) with your left hand up past the vertical support accompany:

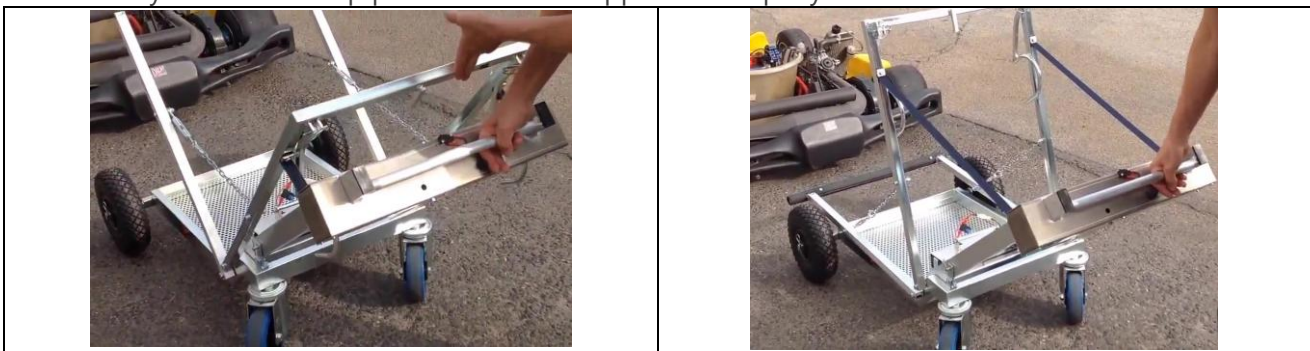

Picture 3

3) Apply the hooks and lower just enough to insert the hooks in the rear bumper:



Picture 4

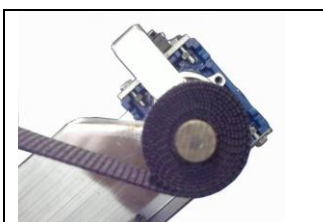

**STOP the MOTOR otherwise the straps around the shaft and wrap the other side (the BELTS MUST BE WRAPPED UNDER the axis)**

|                  |  |  |  |  |  |  |
|------------------|--|--|--|--|--|--|
| <b>Dalmi srl</b> | <b>Instruction manual: lifting trolley FOX</b> |  |  |  |  |  |
| Date             | 18-12-2015                                     |  |  |  |  |  |
| Revision         | Ver.0  |  |  |  |  |  |

- 4) move the switch to the right to raise the kart. At the end of its travel, the motor stops:  
**(do not install fuses greater than 15 Amps)**



Picture 5

- 5) move the switch to the left to lower the kart:



Picture 6

|                  |   |  |  |  |  |  |
|------------------|---|--|--|--|--|--|
| <b>Dalmi srl</b> | Instruction manual: lifting trolley FOX |  |  |  |  |  |
| Date             | 18-12-2015                              |  |  |  |  |  |
| Revision         | Ver.0                                   |  |  |  |  |  |

**CLOSING:**

|  |  |
|--|--|
| <p>Turn the hooks inwards and completely wrap the straps.</p>  |    |
| <p>Remove the 2 pins placed above and close the holder with the motor.</p>   |   |
| <p>Disconnect the cables from the battery, remove the battery from your cart to decrease weight to load it in the car.</p> |  |



|                  |   |  |  |  |  |  |  |
|------------------|---|--|--|--|--|--|--|
| <b>Dalmi srl</b> | Instruction manual: lifting trolley FOX |  |  |  |  |  |  |
| Date             | 18-12-2015                              |  |  |  |  |  |  |
| Revision         | Ver.0                                   |  |  |  |  |  |  |

## Chapter 7 MAINTENANCE AND PERIODIC CLEANING

**BEFORE CARRYING OUT ANY MAINTENANCE OPERATION, BE SURE TO DISCONNECT THE CABLES FROM THE BATTERY, AND THAT ARE IMPOSSIBLE ACCIDENTAL STARTER.**

**Warning: the staff that performs the following operations must be provided with appropriate personal protective equipment (gloves, safety shoes, glasses, etc.);!!**

**It is forbidden to carry out maintenance or repairs with lifting trolley moving; operations such as clean, adjust or repair should be carried out with the machine stopped.**

The regularity of these measures ensures long life of the mechanical parts and prevents damage that might compromise the security of the cart and then the safety of persons.

**If a repair has been made consistent and significant, the cart should be retested.**

After completing maintenance work before using the cart, check:

- That have been removed pieces eventually replaced, tools used for surgery or other foreign objects.
- That all safety devices are present and efficient.
- That all the symbols and safety signs are present, in good condition and legible.

### **Mechanical components**

The cart is designed to reduce to a minimum the maintenance time, for the proper functioning of the machine periodically

- Check that the main structure are not deformation, damage or dents that compromise the correct operation.
- Ensure State support straps hooks.
- Check tie rod adjustment front support.
- Check the rubber on the front support
- Check the tightening of the screws of the principal organs.

### **Electrical system**

- Inspect and test electrical functions.
- Check that there are no damaged wires, fix them if necessary.

**TABLE MAINTENANCE**

| DESCRIPTION                             | CADENCE |         |        |
|---|---------|---------|--------|
|   | 1 day   | 30 days | 1 year |
| Charging batteries                      | ✓       |         |        |
| Progress control of belts               |         | ✓       |        |
| Control securities                      |         | ✓       |        |
| Check tie rod adjustment                |         | ✓       |        |
| Rubber control front support            |         |         | ✓      |
| Progress control kartlift wheels        |         |         | ✓      |
| Lubricate the moving parts              |         |         | ✓      |
| Screw tightening check principal organs |         |         | ✓      |
| Geared motor control                    |         |         | ✓      |

|                  |  |  |  |  |  |  |  |
|------------------|--|--|--|--|--|--|--|
| <b>Dalmi srl</b> | <b>Instruction manual: lifting trolley FOX</b> |  |  |  |  |  |  |
| Date             | 18-12-2015                                     |  |  |  |  |  |  |
| Revision         | Ver.0  |  |  |  |  |  |  |

## Chapter 8 TROUBLESHOOTING

Here are some malfunctions, causes and action to be implemented:

### FAULT ANALYSIS

| N. | ANOMALY                    | CAUSES   | RIMEDIES   |
|----|----------------------------|--|--|
| 1  | Support hook does not lift | Malfunction of the engine or the gear unit         | Verify operation and repair or replace damaged components  |
|    |                            | No power on motor                                  | Check the connection to the battery pack.<br>Check fuse and replace (must be less than 15 amperes) |
|    |                            | Damaged straps                                     | Replace the belts  |
|    |                            | Straps wrapped over the PIN in the wrong direction | Twist the straps from the bottom   |
| 2  | The front does not lift    | Broken tie chains                                  | Replace damaged part   |

## Chapter 9-COMMISSIONING of LIFTING TROLLEY

If you decide not to use the lifting trolley, you disconnect the battery.

Removing individual components of the trolley, which must be disposed of according to current regulations in the place where they are located, using municipal landfills or fish farms for waste disposal, so the different materials in the machine will be divided according to type and disposal regulations. Do not dispose of waste into the environment, whatever their nature.

The dismantling of the cart you must observe all safety and accident prevention.

Below is a table showing the main components are associated with the type of material:

| Component       | Type              |
|-----------------|-------------------|
| Trolley frame   | Steel or aluminum |
| Gear motor      | See manual        |
| Engine          | See manual        |
| Batteries       | See manual        |
| Battery charger | See manual        |
| Wheels          | Steel and rubber  |